

P1

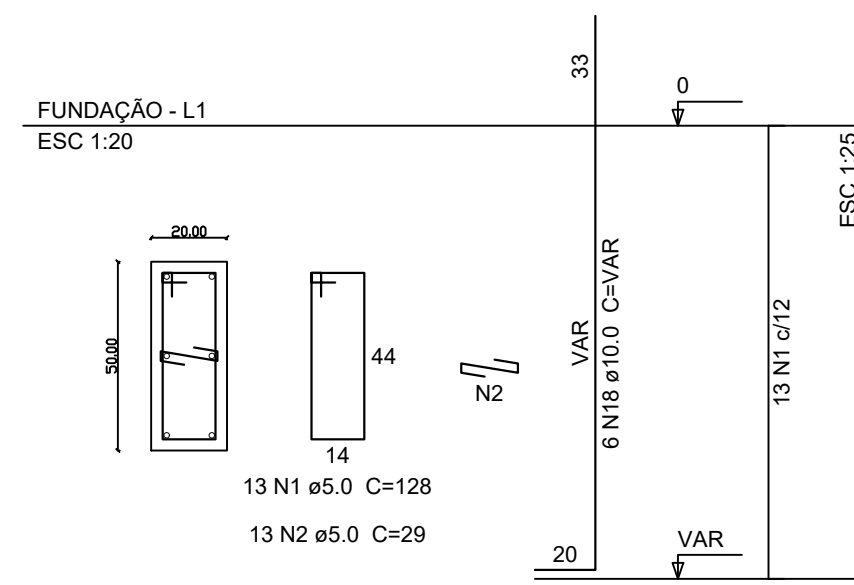

P3=P13=P16=P26

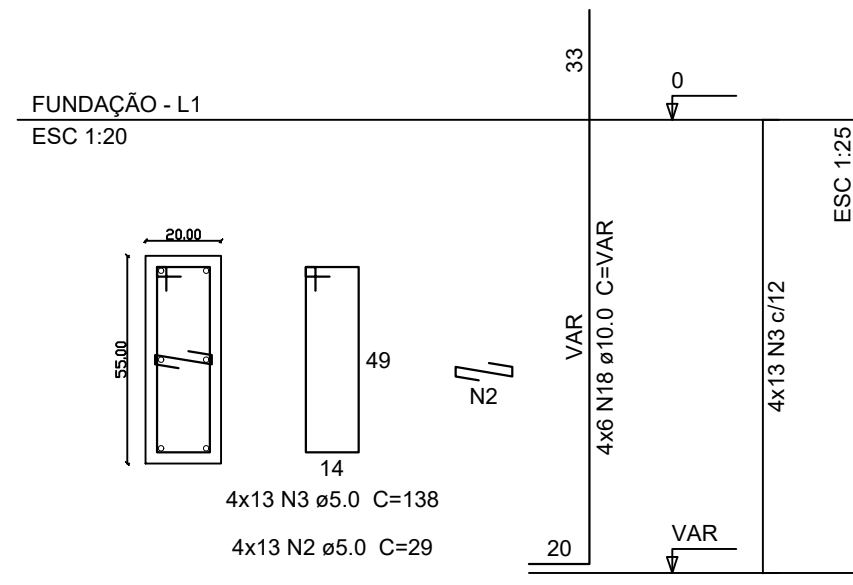

S1=S3=S13=S16=S26

PLANTA
ESC 1:25

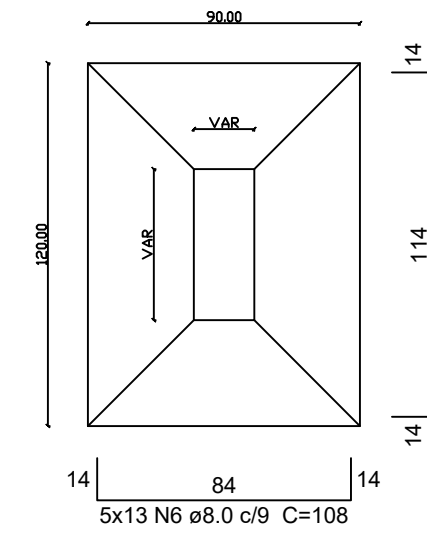

Solo com capacidade de suporte > 150.00 kN/m²
Solo compactado sobre a sapata
peso específico > 16.00 kN/m³

CORTE
ESC 1:25

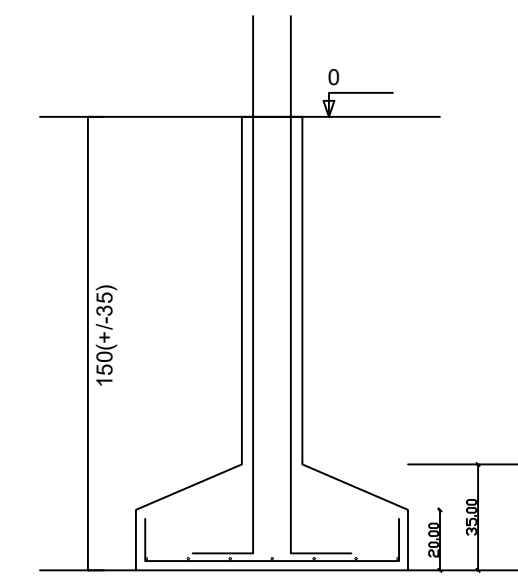

Relação do aço

AÇO	N	DIAM	Q	UNIT (cm)	C.TOTAL (cm)
CA60	1	5.0	52	128	6656
	2	5.0	104	29	3016
	3	5.0	52	138	7176
	4	5.0	286	98	28028
	5	5.0	338	24	8112
CA50	6	8.0	65	108	7020
	7	8.0	83	138	11454
	8	8.0	206	118	24308
	9	8.0	56	143	8008
	10	8.0	45	93	4185
	11	8.0	10	88	880
	12	8.0	6	118	708
	13	8.0	44	103	4532
	14	8.0	28	128	3584
	15	8.0	9	103	927
	16	8.0	7	123	861
	17	8.0	14	168	2352
	18	10.0	176	VAR	VAR
	19	10.0	24	VAR	VAR
	20	10.0	14	142	1988

Resumo do aço

AÇO	DIAM	C.TOTAL (m)	PESO + 10 % (kg)
CA50	8.0	688.2	298.7
CA60	5.0	413.3	280.3
PESO TOTAL			
CA50	579		
CA60	89.8		

Vol. de concreto total (C-30) = 11.8 m³
Área de forma total = 78.8 m²

P2=P18=P21

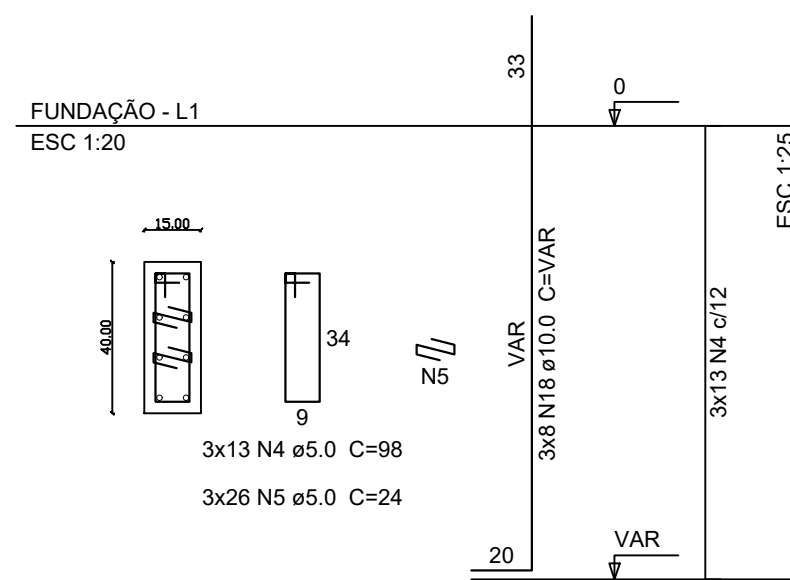

P24

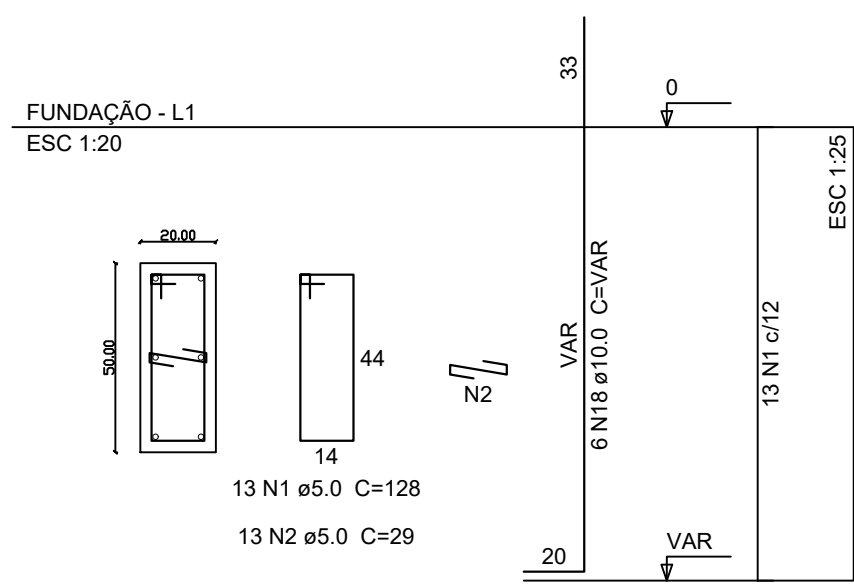

P6=P9=P25

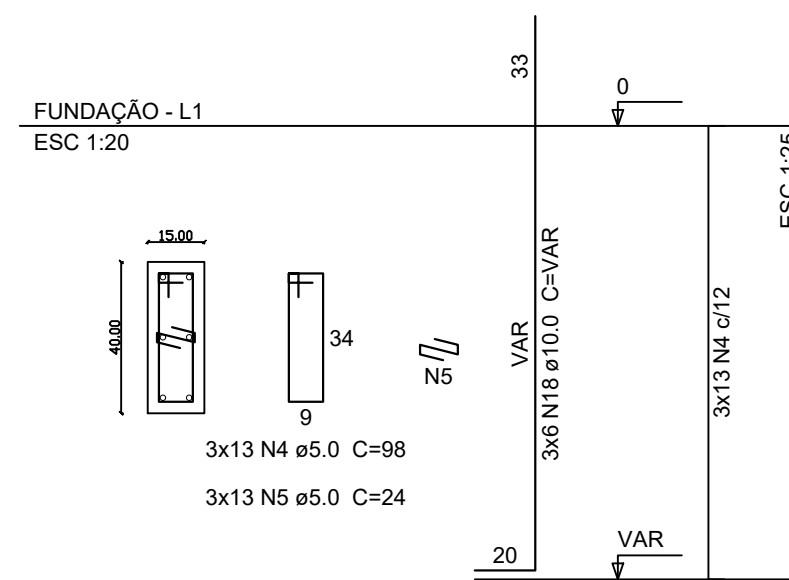

S2=S6=S9=S18=S21=S24=S25

PLANTA
ESC 1:25

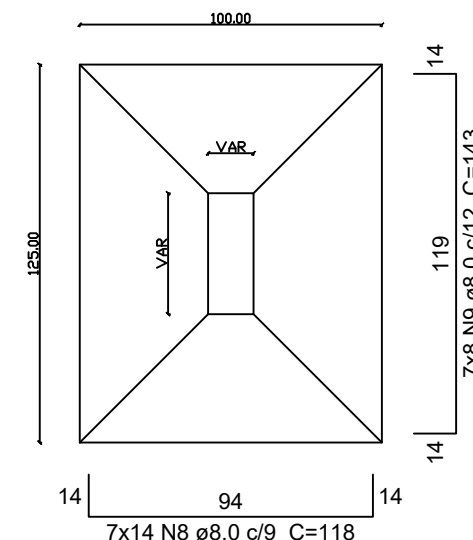

Solo com capacidade de suporte > 150.00 kN/m²
Solo compactado sobre a sapata
peso específico > 16.00 kN/m³

CORTE
ESC 1:25

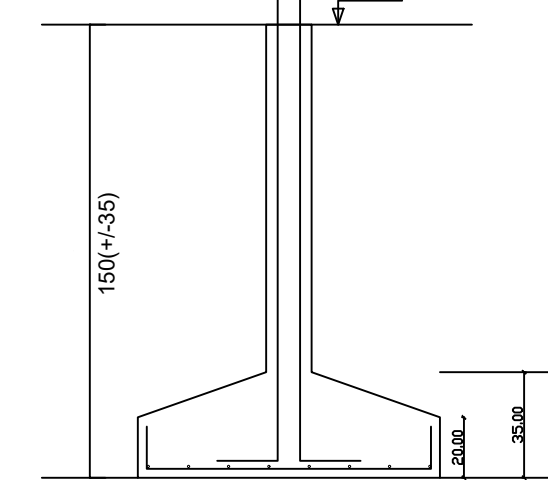

P8=P17

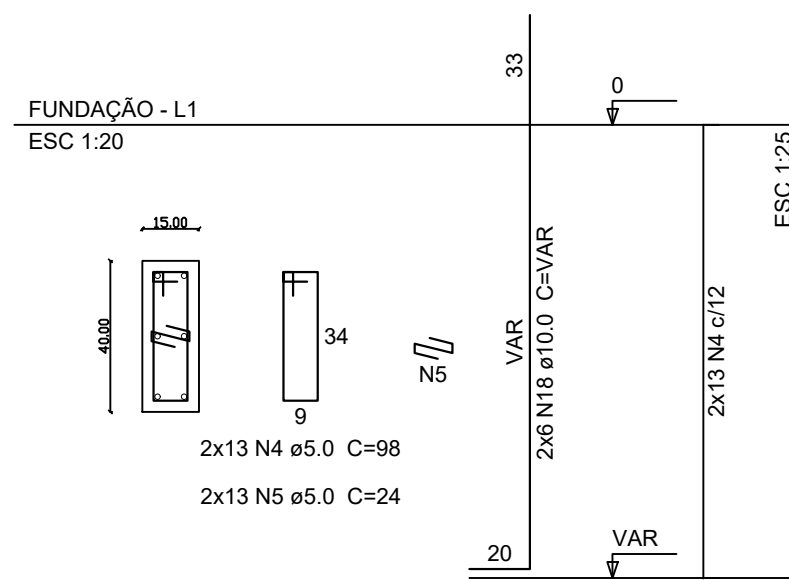

P4=P23

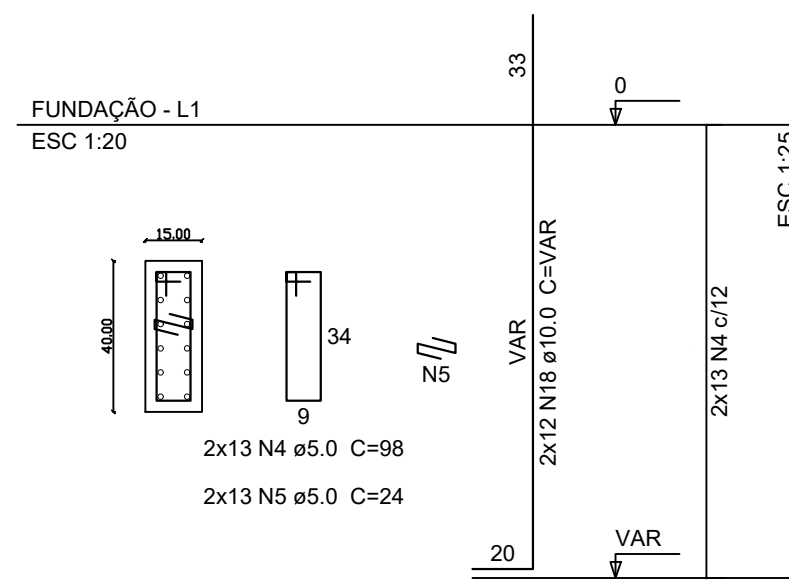

P29

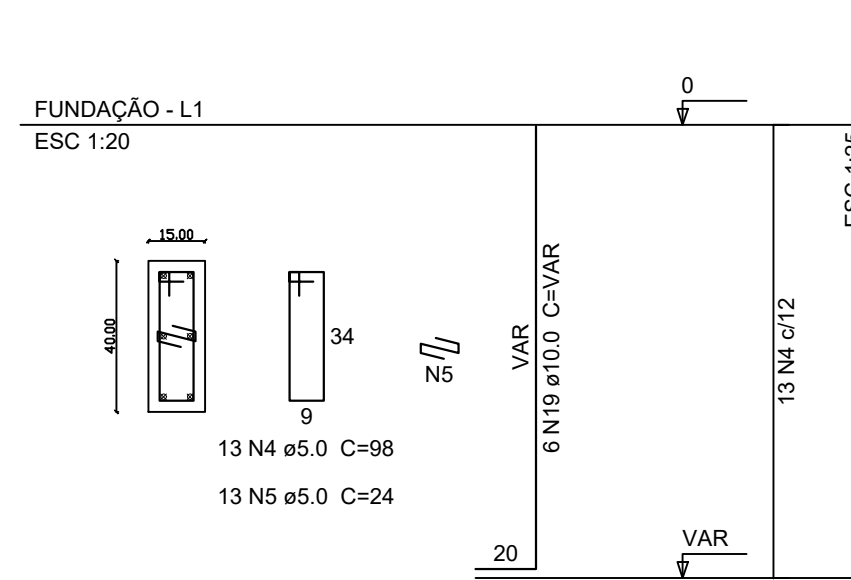

S4=S8=S17=S23=S29

PLANTA
ESC 1:25

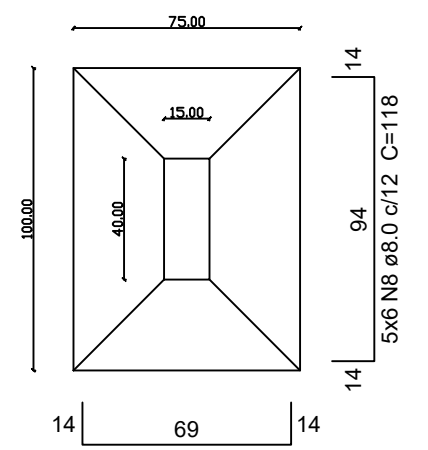

Solo com capacidade de suporte > 150.00 kN/m²
Solo compactado sobre a sapata
peso específico > 16.00 kN/m³

CORTE
ESC 1:25

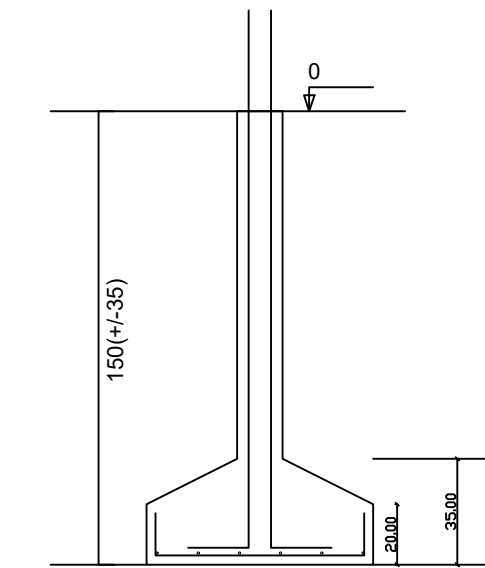

S11=S12=S14=S15=S28=S30

PREFEITURA MUNICIPAL DE GOVERNADOR LINDENBERG

TÍTULO:
PROJETO DE AMPLIAÇÃO - CEIM ARCO-ÍRIS

TIPO I
ESTRUTURAL

NOVEMBRO DE 2024	ÁREA TOTAL	ESCALA
CONTEÚDO DETALHAMENTO DAS SAPATAS	400 m ²	indicada
ASSUNTO PROJETO ESTRUTURAL DE AMPLIAÇÃO CEIM ARCO-ÍRIS	ENDEREÇO RUA PROJETADA, NOVA BRASÍLIA, GOVERNADOR LINDENBERG - ES	CONJUNTO 06 03 10

PREFEITO LEONARDO PRANDO FINCO	PREFEITURA MUNICIPAL DE GOVERNADOR LINDENBERG CNPJ-04.247.786/0001-54 (27) 3604-1010
RESP. TÉCNICO MARLLONE DOS SANTOS PLOTTEGHER CREA-ES 0048556/D	